



# **Tube Sauna Installation Guide**

[www.ultimategardenbuildings.com](http://www.ultimategardenbuildings.com)

# Tube sauna



# Preparations for installation

To install a tube sauna, you need the following tools:

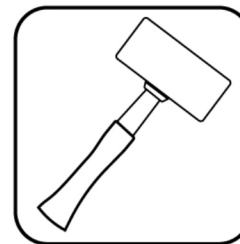
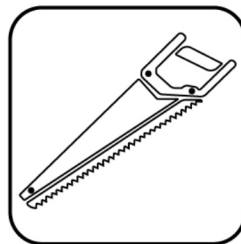
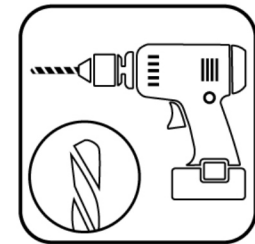
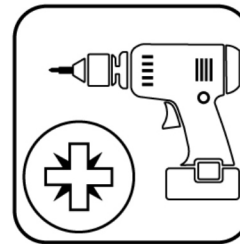
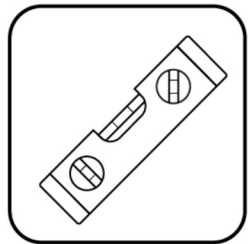
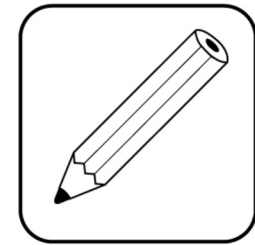
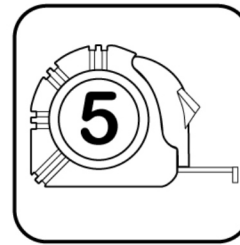
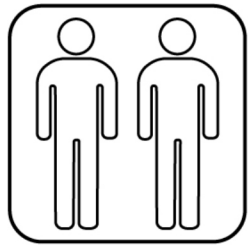

Use the level tool to install the details!

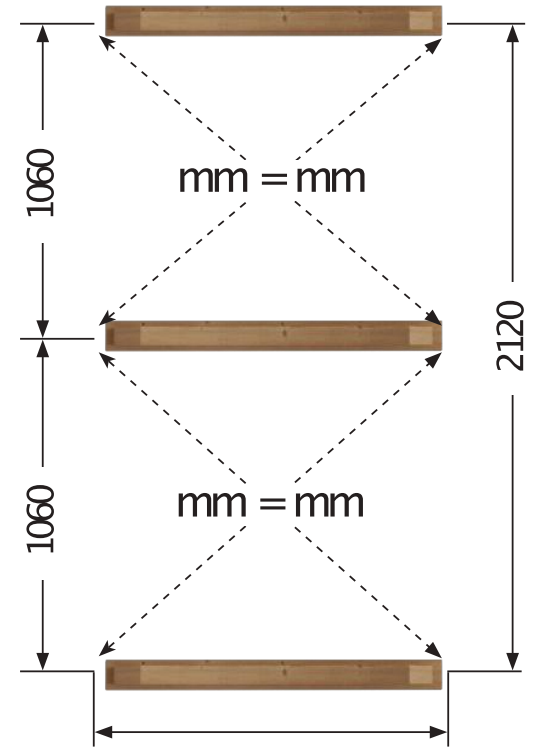
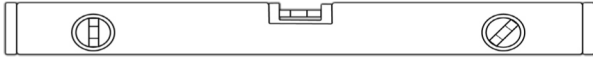

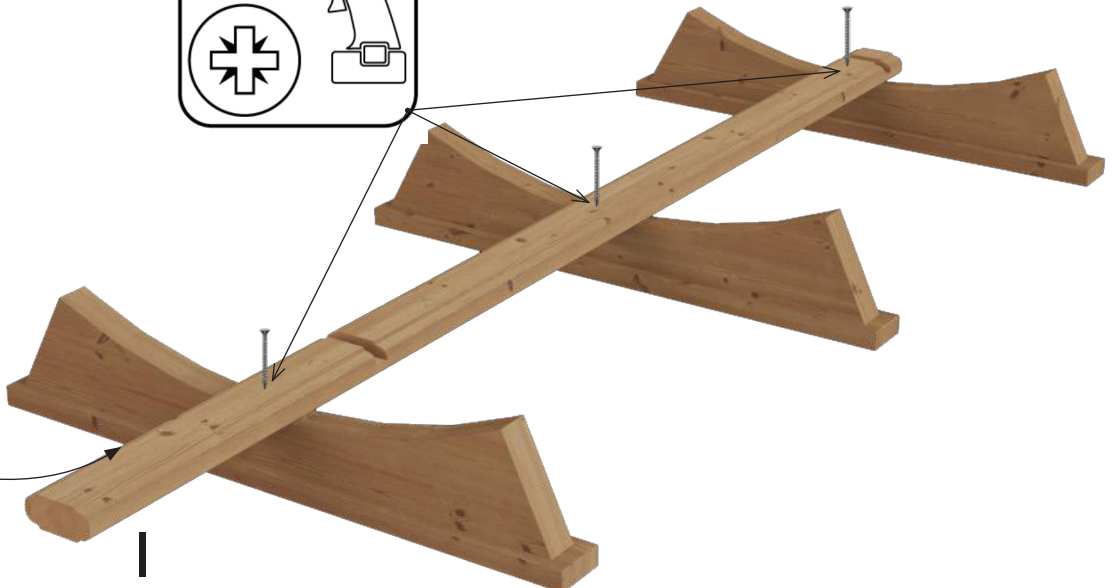
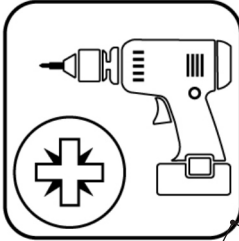
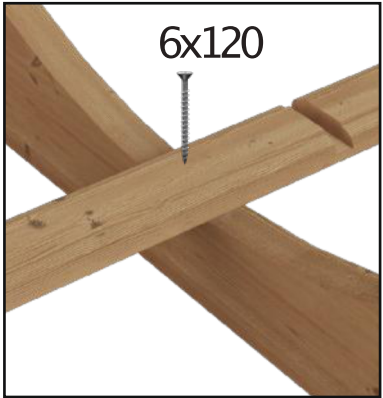

I



II

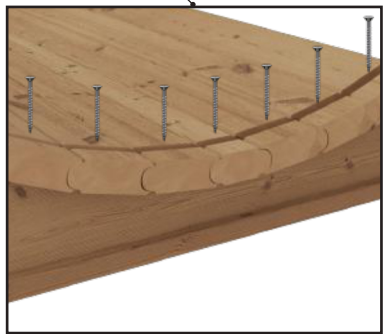

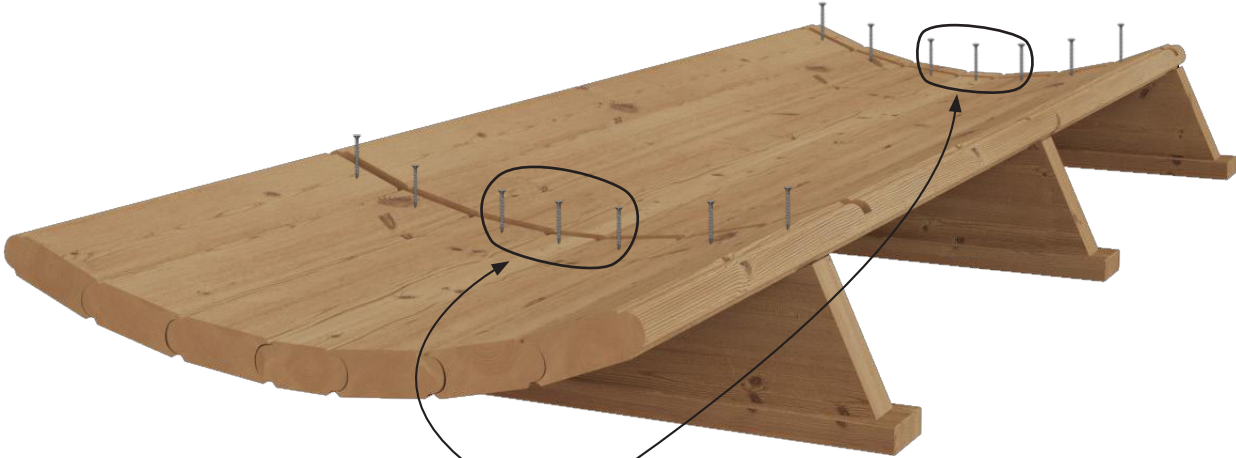

II

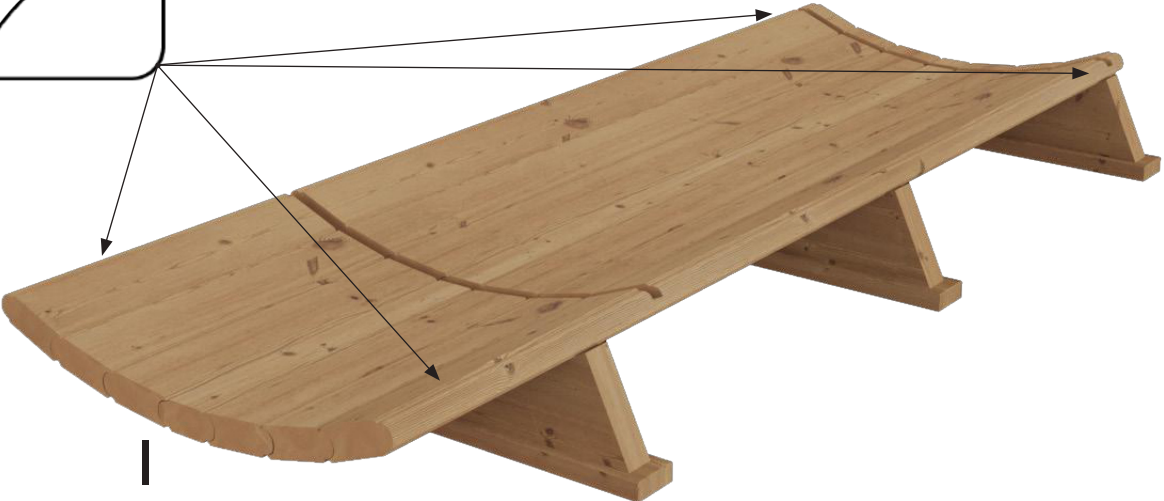

I

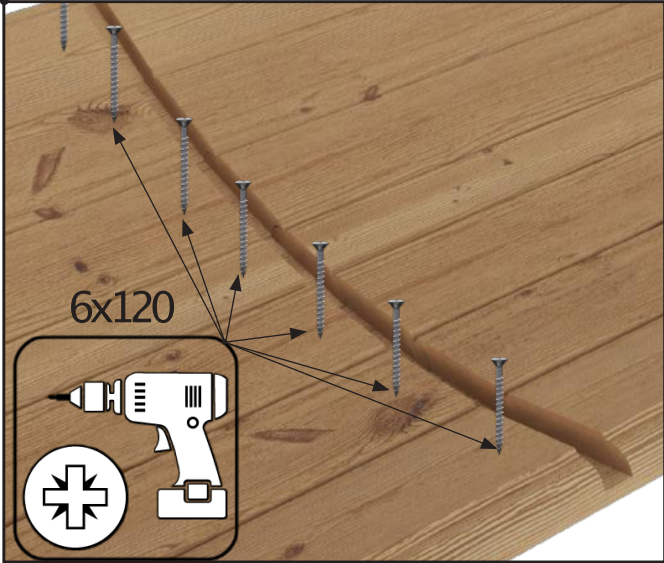

I



II



B



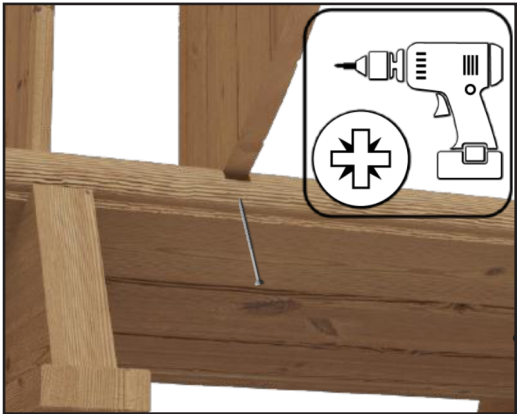

5x90





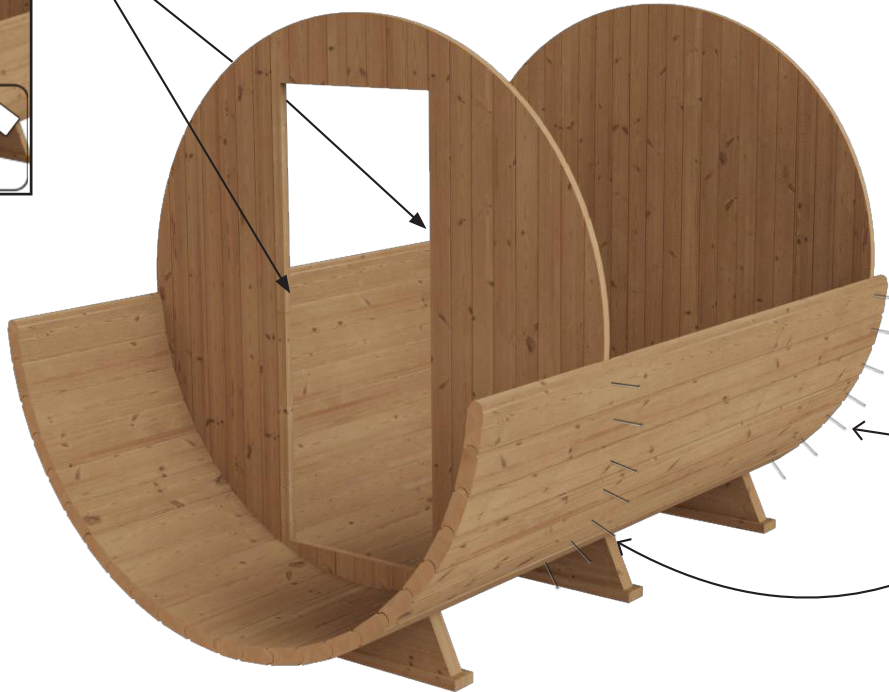
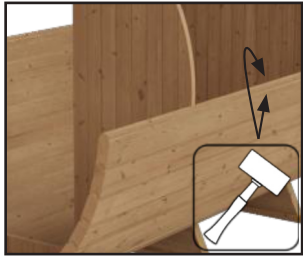
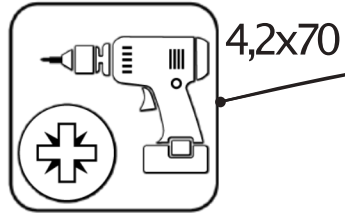

4,2x70

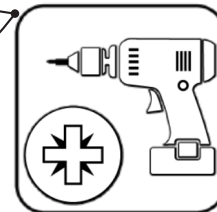

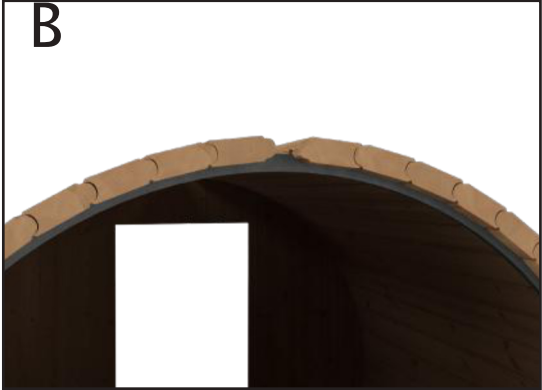
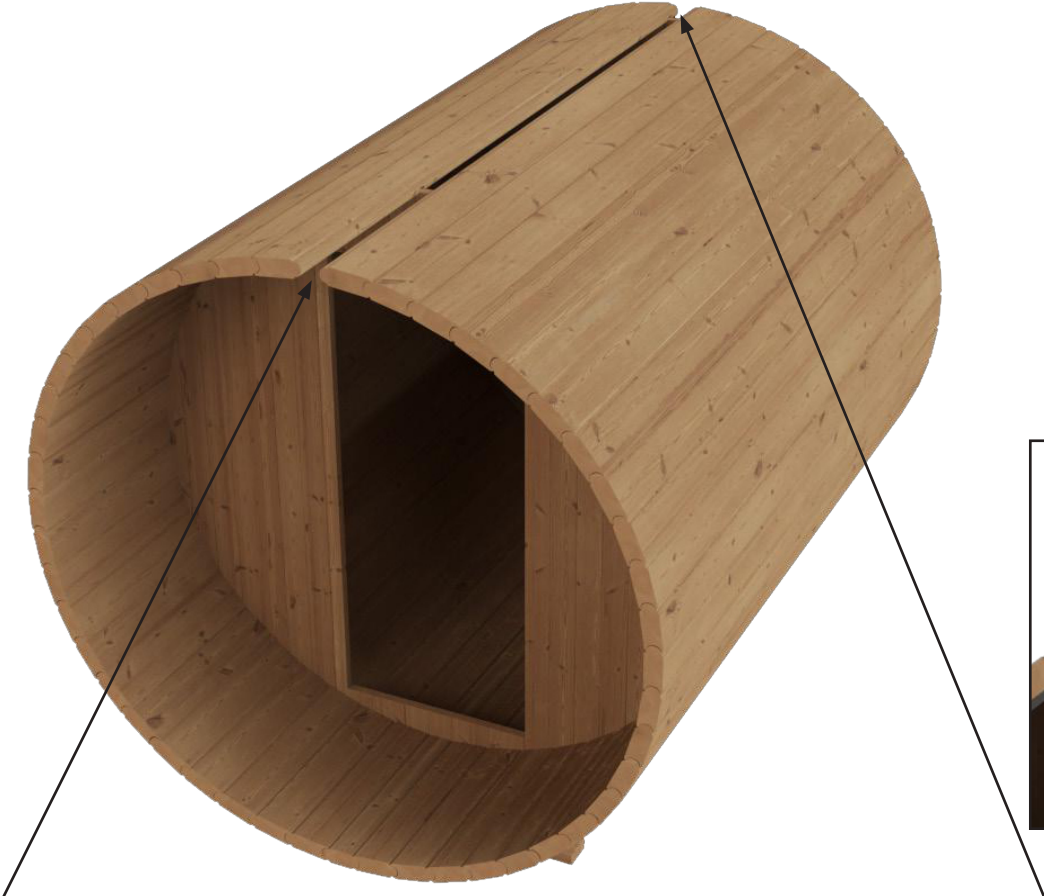

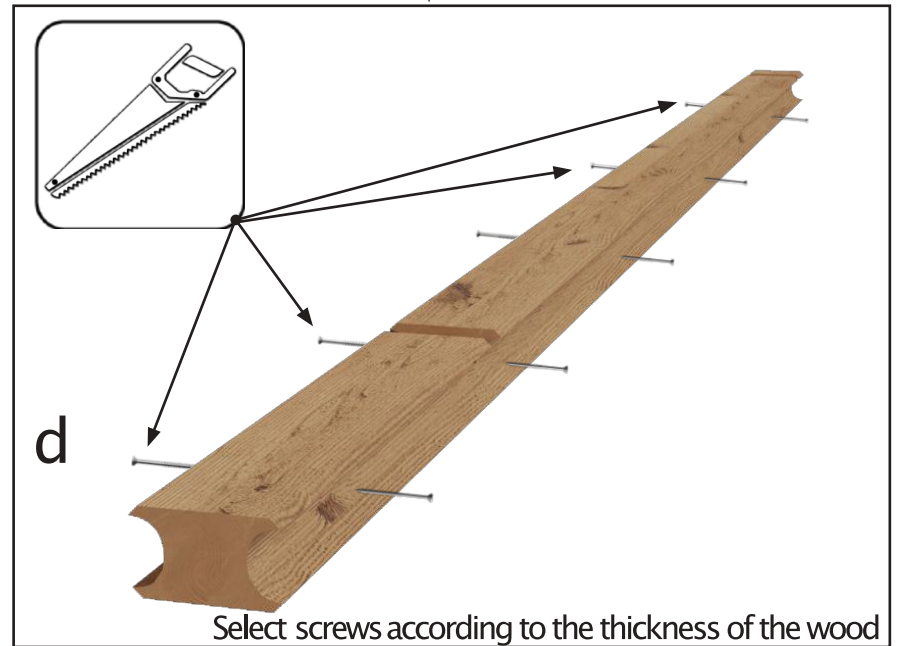
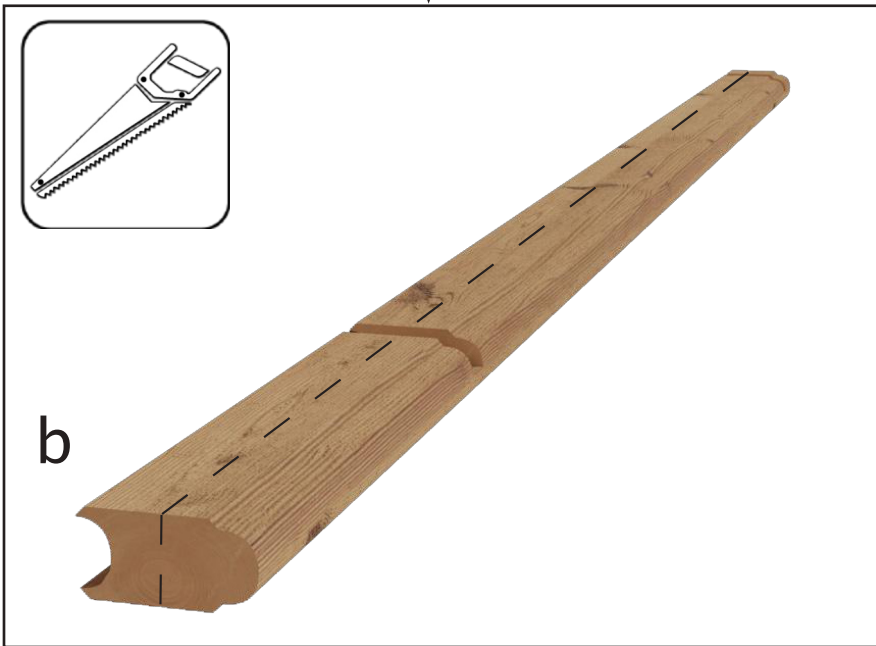
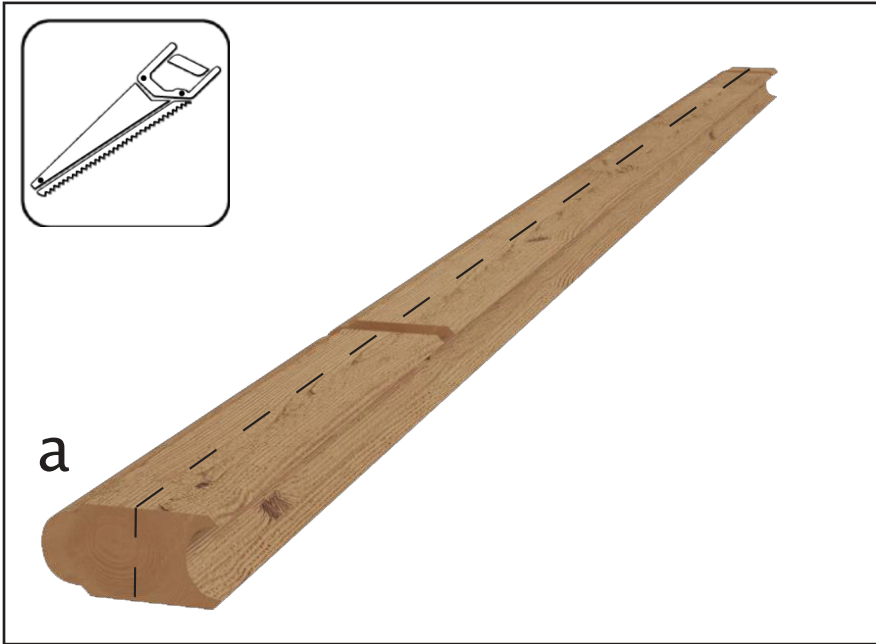

Select screws according to the thickness of the wood

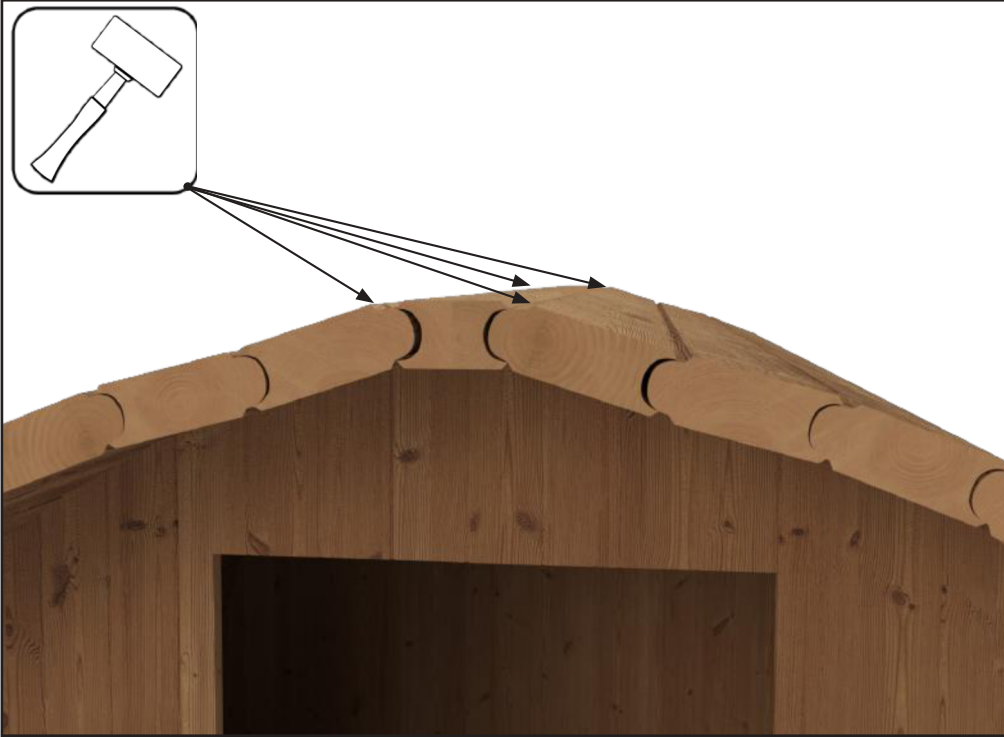

When installing the bands, remove the screws from the housing.

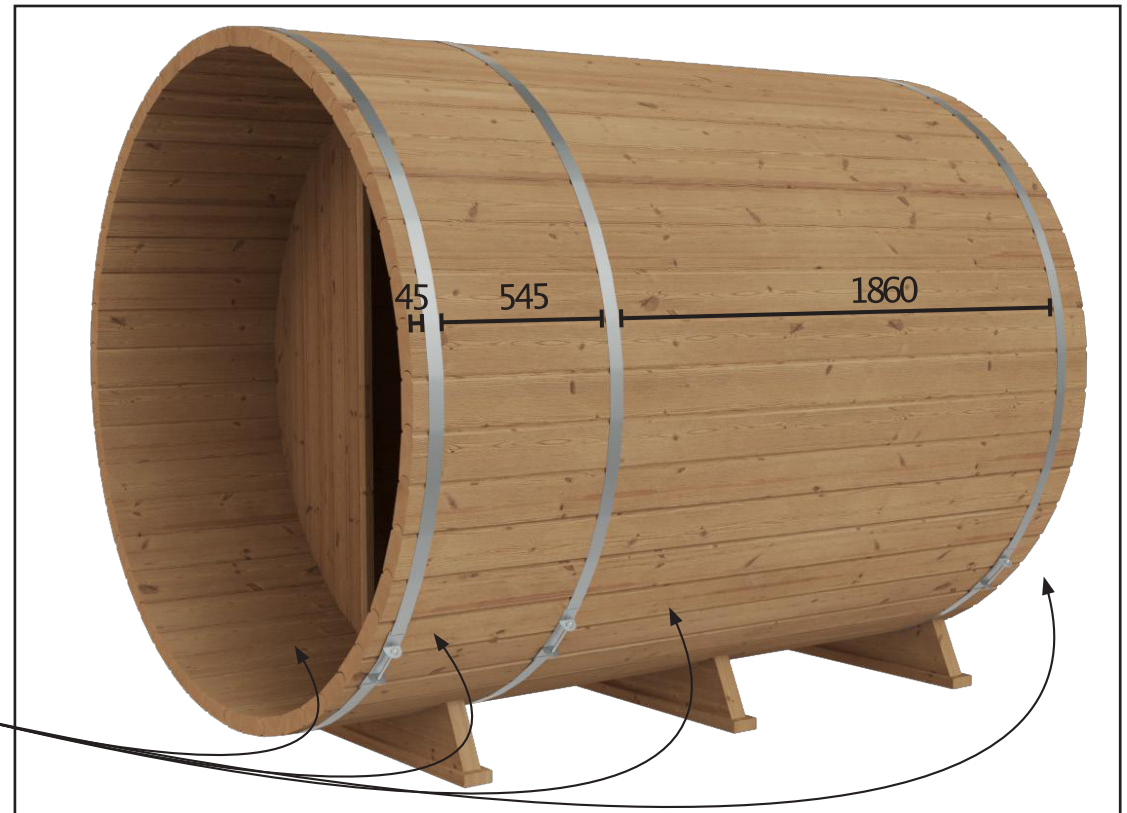
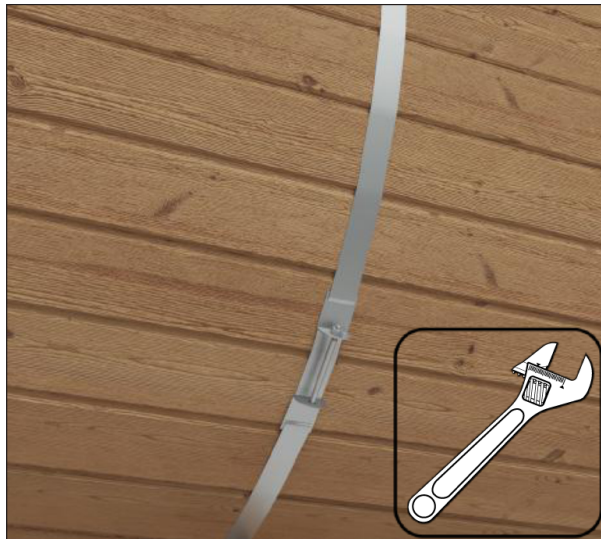
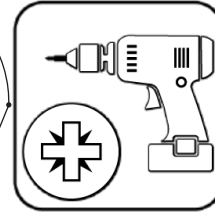
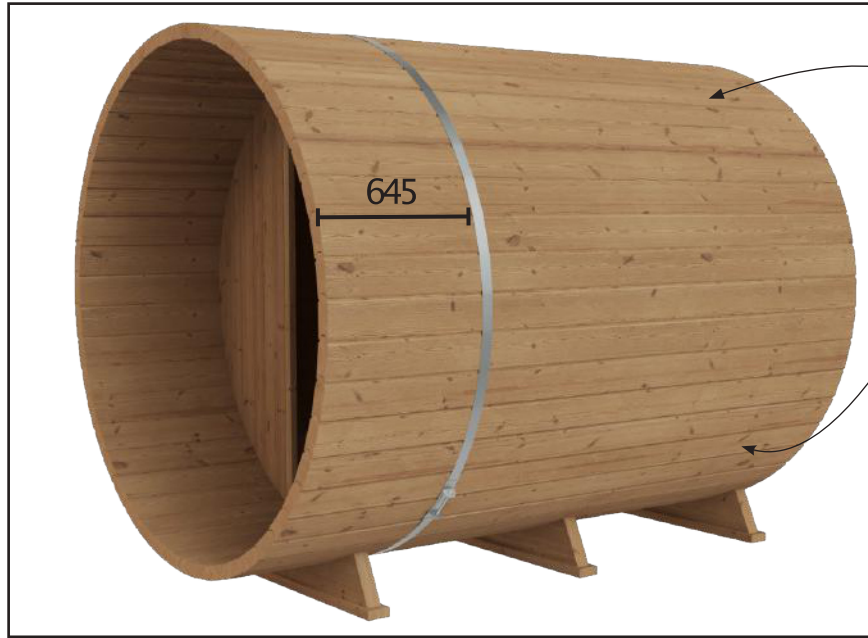



4x40





x4

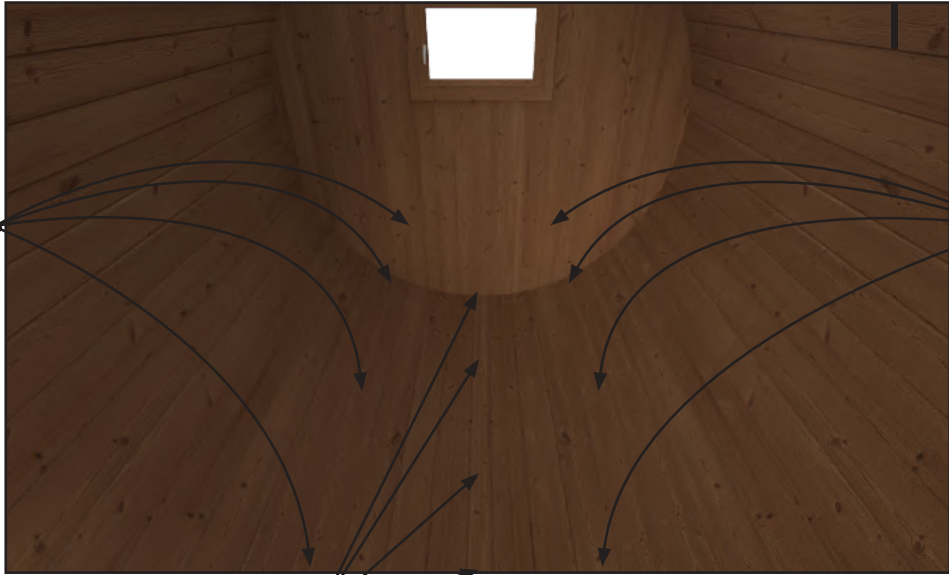
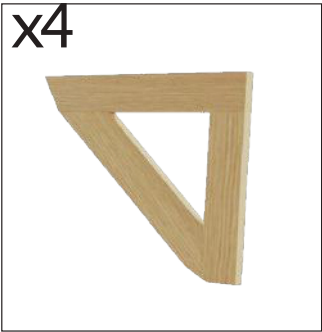

x4

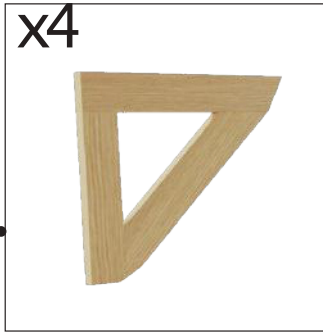

x4

5x100



x2

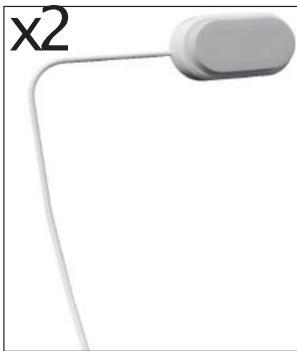



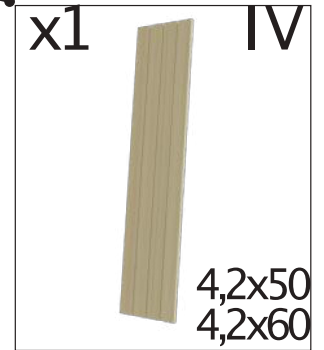
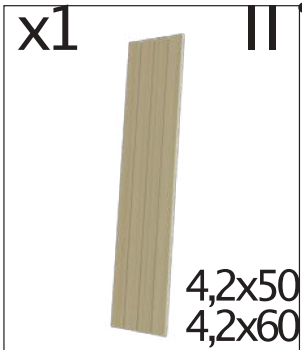
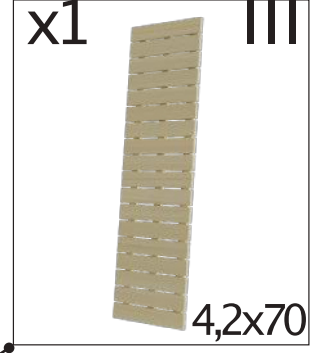
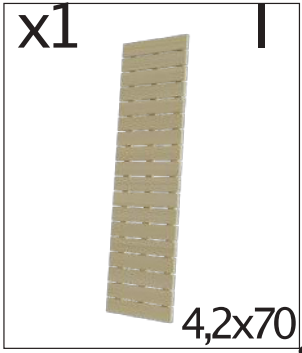

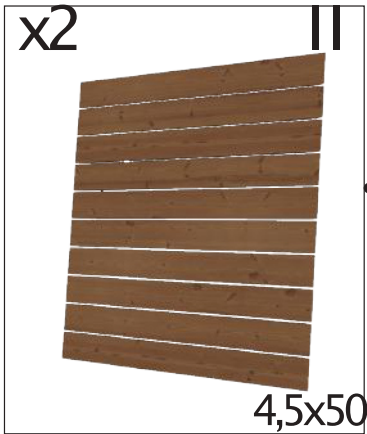

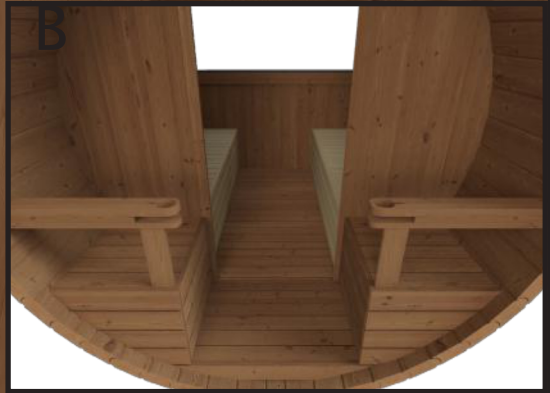

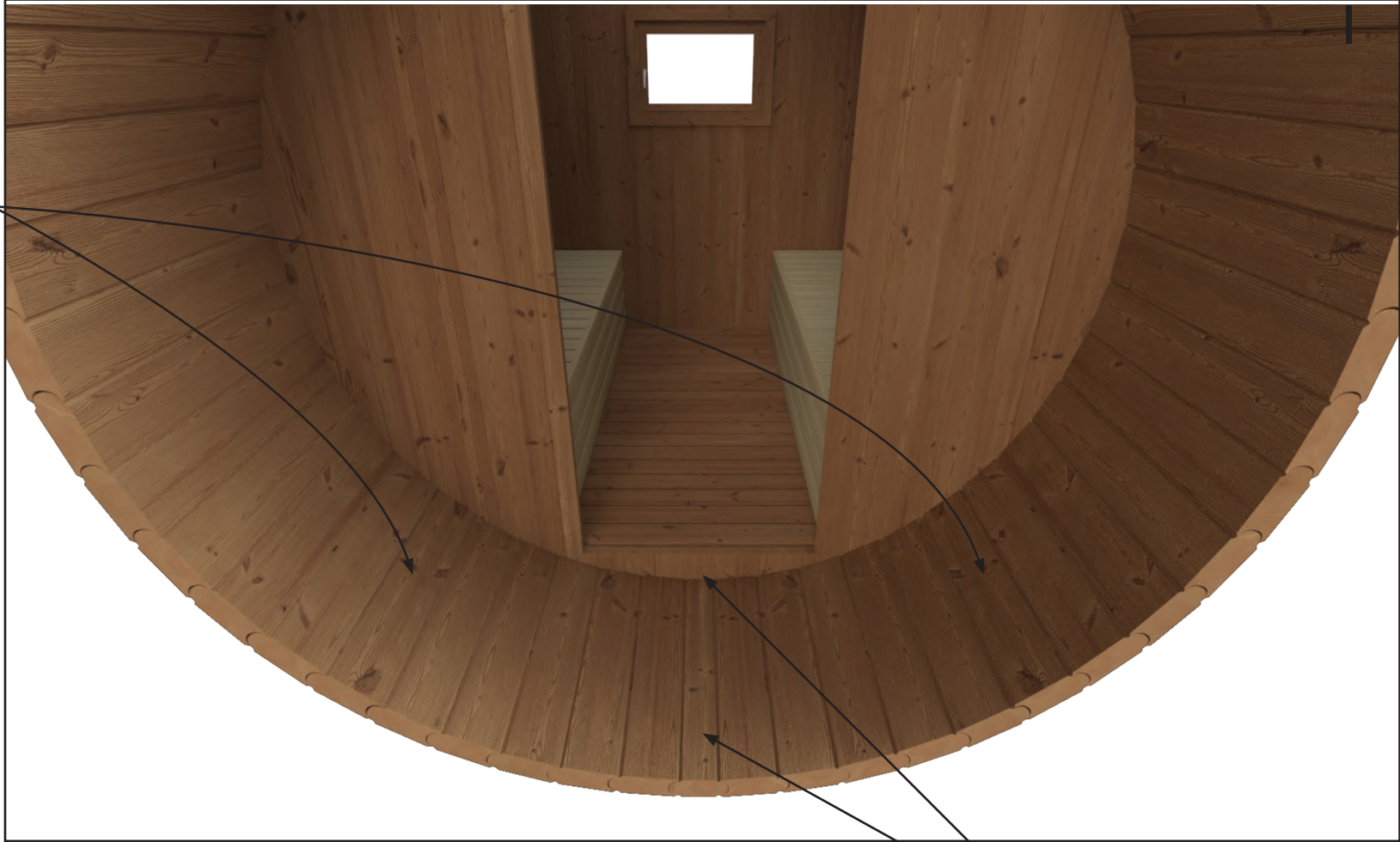
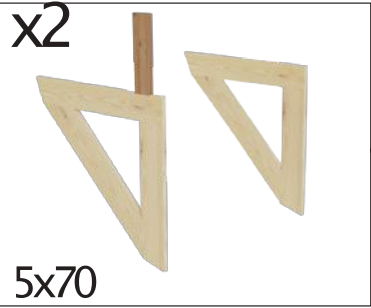

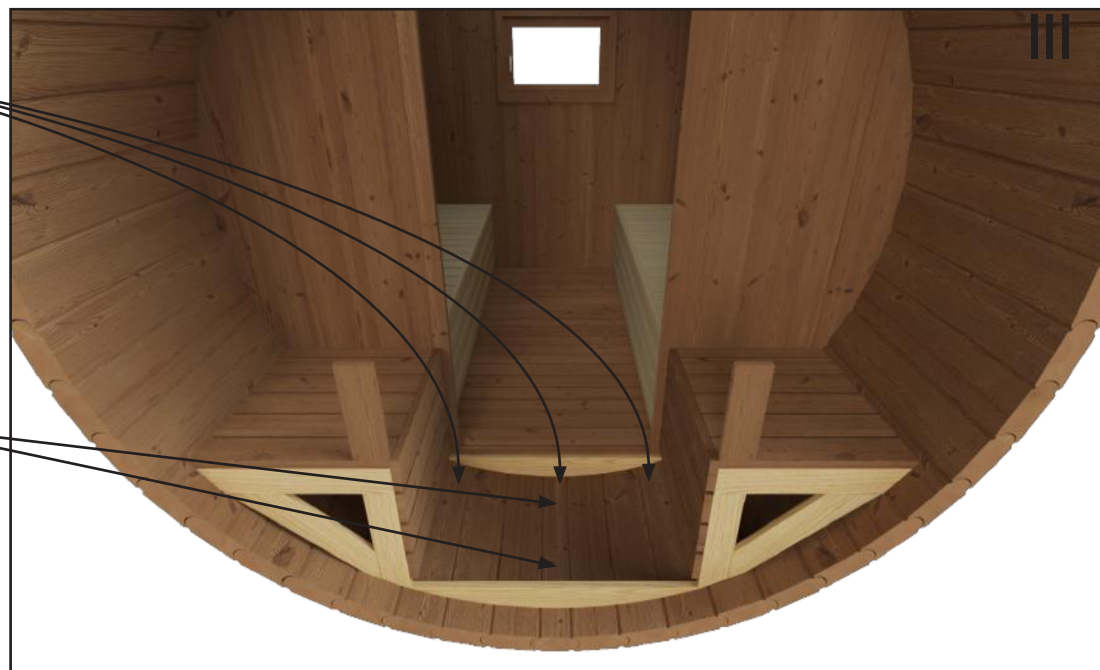
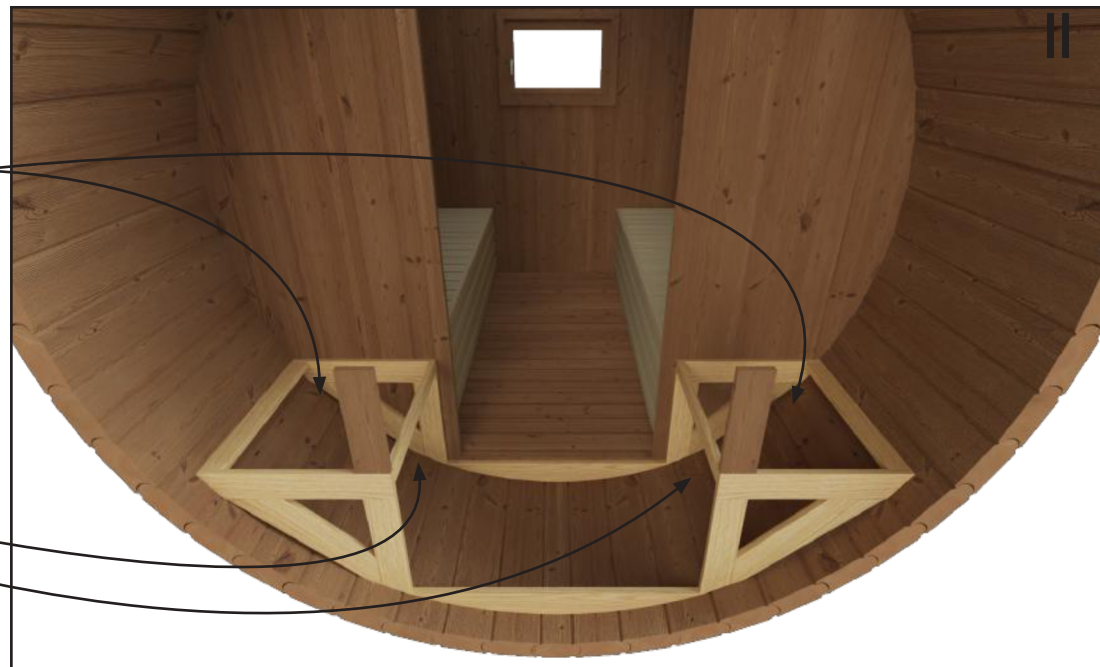
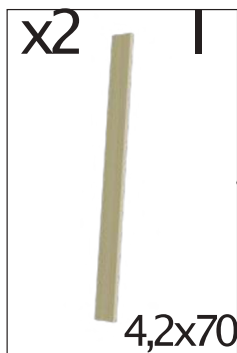
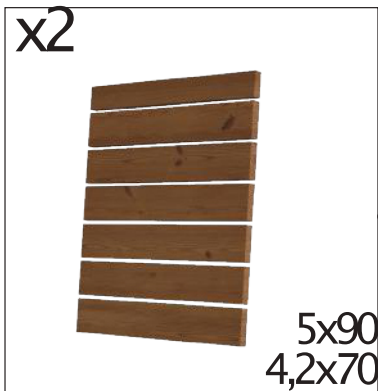
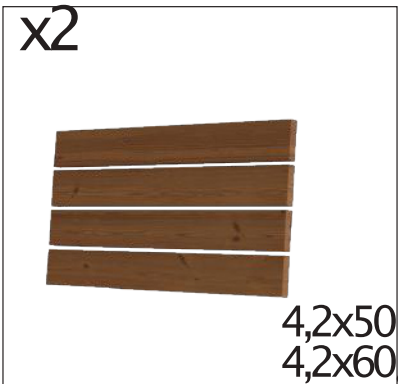

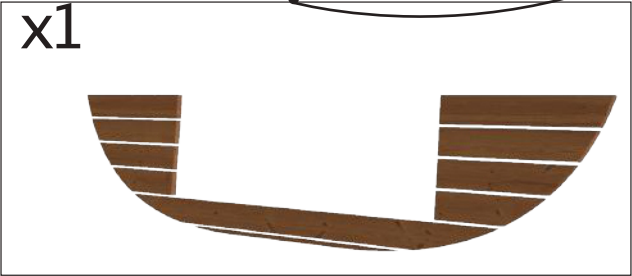

On the terrace armrest, fasten a screw from each side of the band.







